

FORIX™



COMPLETE AND VERSATILE WALL MOUNTING SOLUTION



THE **GLOBAL SPECIALIST**
IN ELECTRICAL AND DIGITAL BUILDING INFRASTRUCTURES

 **legrand®**

Complete and versatile

Suitable for all

RESIDENTIAL

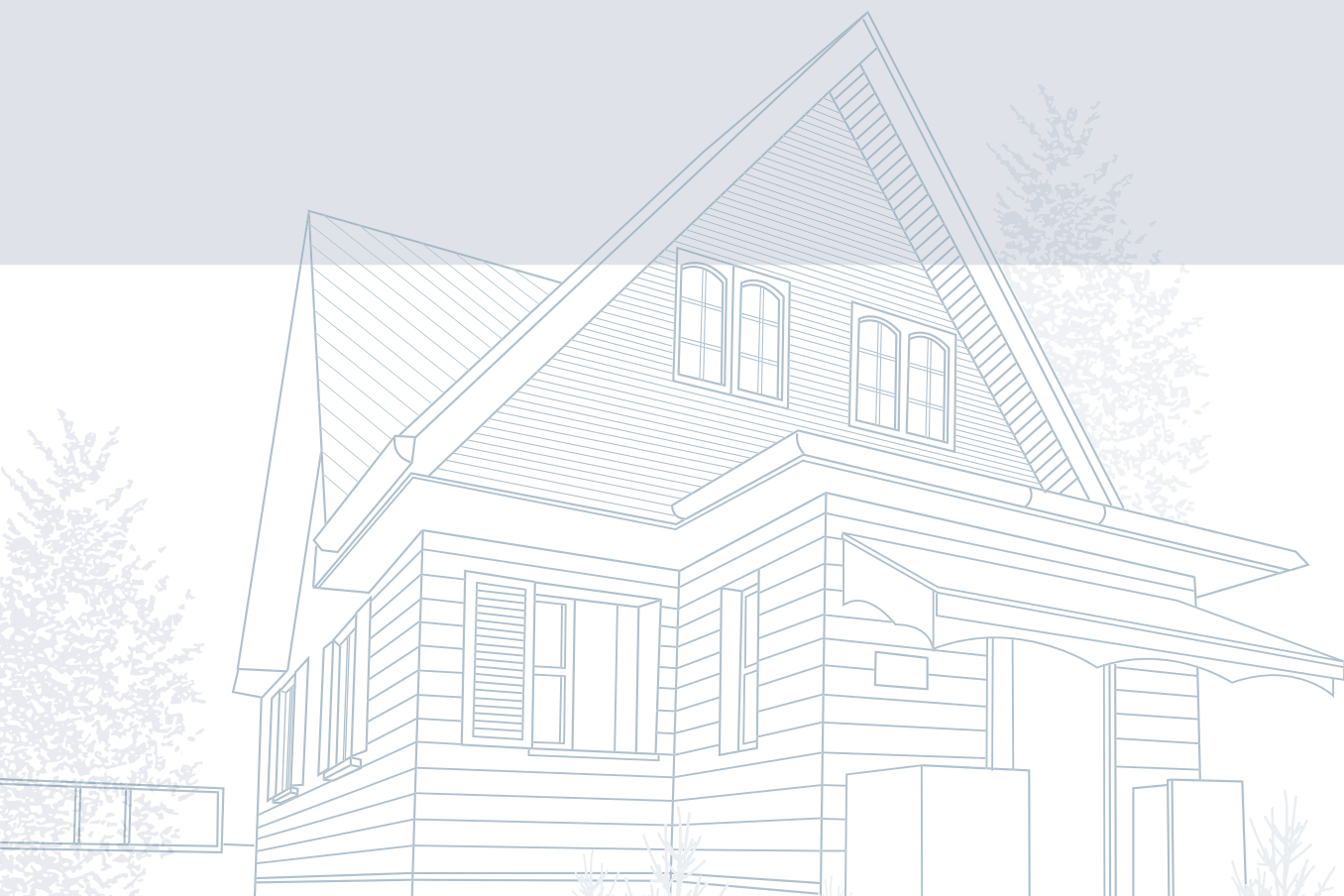
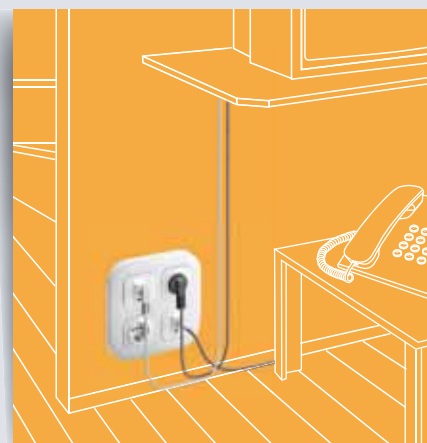
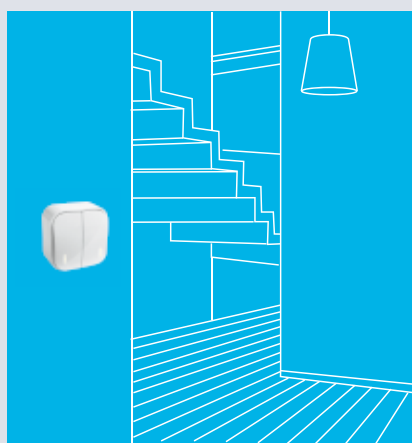

applications



Damp environment



SERVICE SECTOR AND SMALL COMMERCIAL

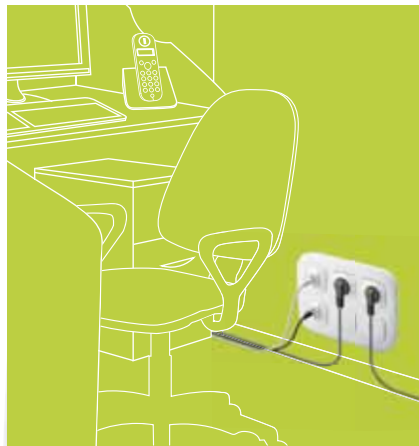

- Aesthetically-pleasing design
- Safe and easy installation
- IP 44 - Gloss finish, backlighting and ergonomic design
- WORKSTATION - A flexible multi-gang solution

Aesthetically-pleasing design

Compact and sober in two colours



**Devices are available
in two colours: white and ivory**



WHITE



IVORY

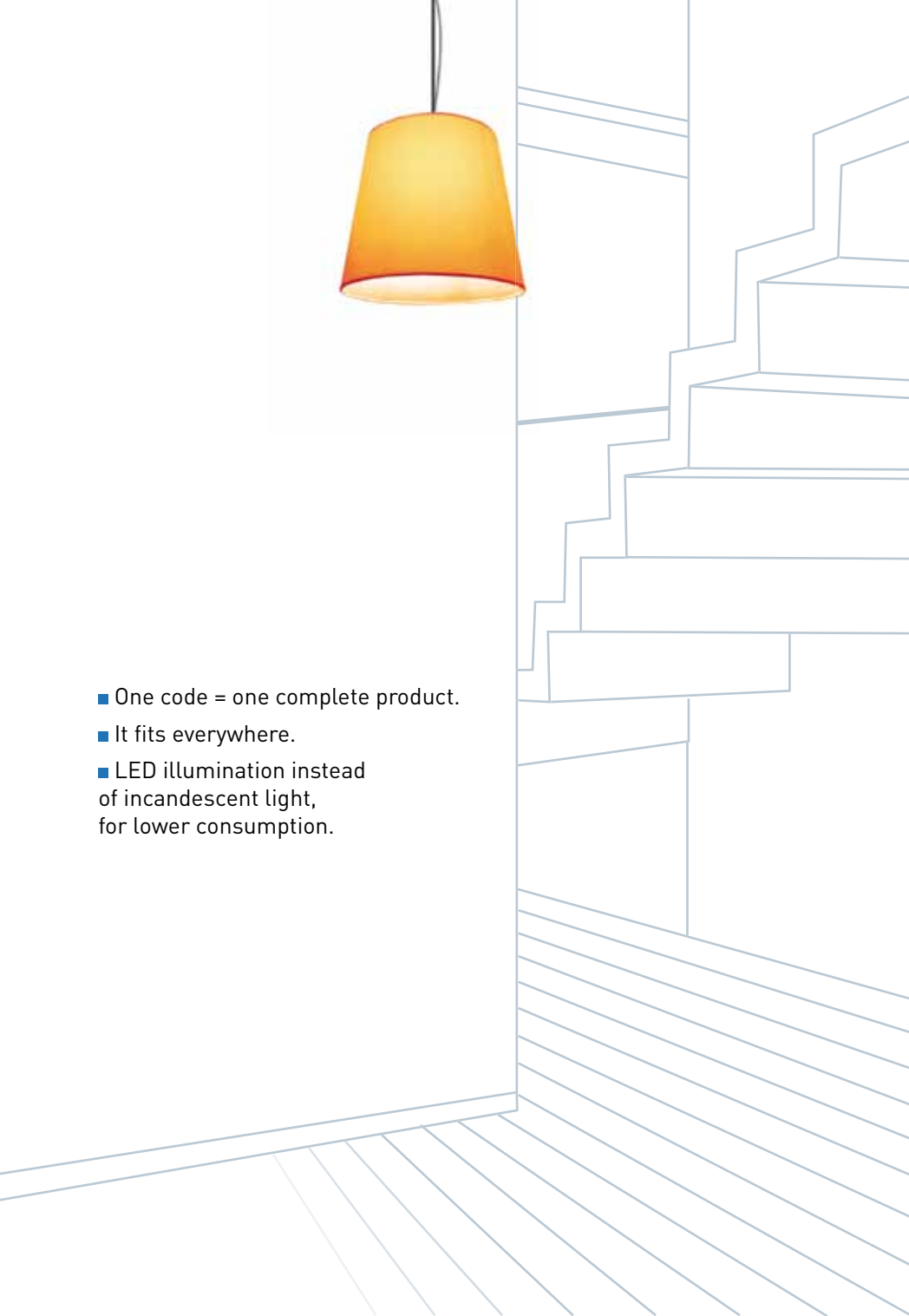

- One code = one complete product.
- It fits everywhere.
- LED illumination instead of incandescent light, for lower consumption.



Example of using a 2 gang one-way switch

Smooth shape and gloss finish



Safe and easy installation

Protection while working

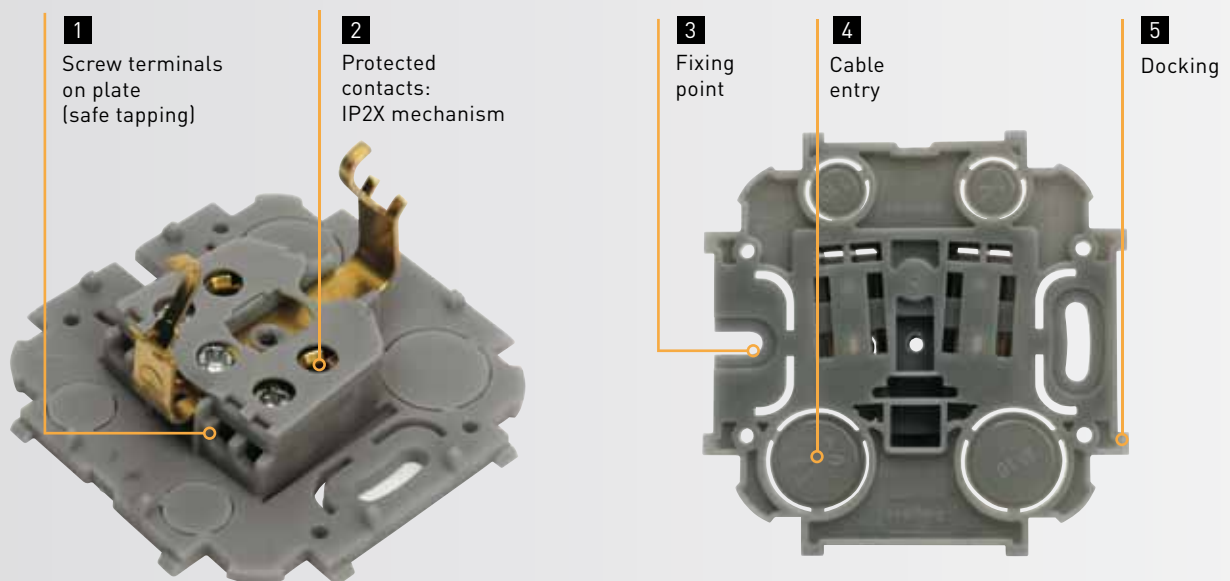

It complies with all standard requirements

- 1** For guaranteed cable connection strength, and easier pass-through wiring
- 2** Finger contact with live parts of the mechanism not possible during installation
- 3** The fixing point area could be deformed when the wall surface is not perfect, horizontal adjustment is possible
- 4** 4 rear wire entries and lined terminals for simplified wiring
- 5** An easy way to create multi-gangs



Example of using a 4 gang workstation, to have safe and tidy access to power and data.

Double and triple sockets can be installed in both horizontal and vertical positions thanks to the holes at 45°



Gloss finish, backlighting and ergonomic design



The new weatherproof range offers the answer to all your applications where an IP 44 protection index is required. Essential functions, very simple installation, ergonomic design and 2 colours of gloss finish - white and grey - characterise it.

Two colours and a gloss finish



WHITE DEVICE



GREY DEVICE

Compactness



DOUBLE SOCKET OUTLET



Example using an IP44 socket outlet in a damp environment

Solutions which simplify the job

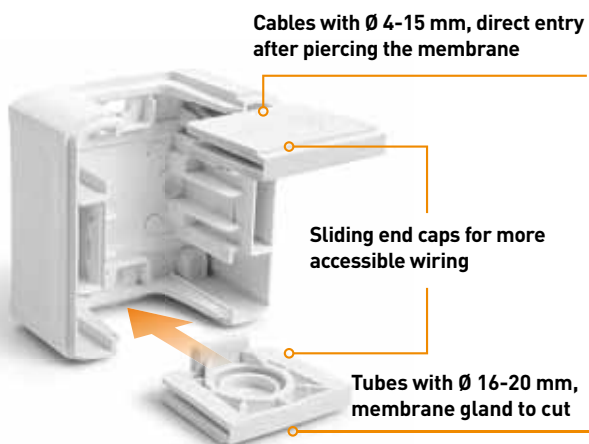

All controls can be illuminated with LEDs*

Two different feedbacks with the same rocker: simple light feedback or illuminated bell symbol



Push-button with illuminated bell symbol

Simply rotate cover plate to change the feedback

Bell Simple light feedback

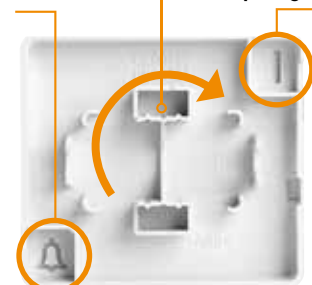

Installer is selecting information while clipping the cover plate

*Except 2 gang switches

WORKSTATION

The flexible multi-gang solution

Perfect
for the service
sector and small
commercial
areas

- White colour - 4 and 6 gangs
- All types of function can be installed (power sockets, data sockets, switching functions all in a row)
- Perfect for:
Power & data applications (power and data sockets)
Switchboard applications (switching functions)
- Additional Mosaic™ mechanisms could be integrated with an accessory
- Reversible: vertical and horizontal installation





Example using the workstation in a reception area

Installation features

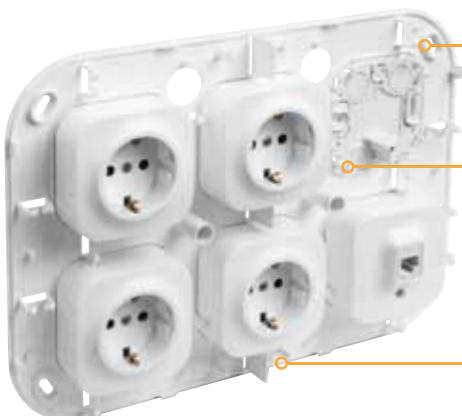

Easy wiring:
space inside
to manage wires

Rigid and robust:
mechanism
clipped onto a plate

Internal divider:
Power vs data sockets

A complete range

Basic and innovative functions

CONTROLS



Two-way switch



Two gang one-way switch



Pushbuttons

SOCKET OUTLETS WITH SHUTTER



French/Belgium standard



German standard



Double German standard socket outlet

IP44 functions



One-way switch



Socket outlet



Double function device

TV and DATA



TV socket



RJ45



RJ11

MISCELLANEOUS DEVICES



Dismatic



Wire outlet

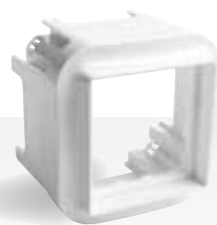

Mosaic™ adaptor

Workstation function versions



6-gang workstation equipped with 4X2P+E German standard socket outlets with shutters



4-gang workstation to be equipped

All the information you need... with a click!

Using the QR Code you can access FORIX products videos directly from a smartphone.
The service is very easy to use and only requires a smartphone with the free software needed to read the code.



1.
TAKE A PICTURE OF THE QR CODE



2.
DOWNLOAD
THE CONTENT



3.
ACCESS THE REQUIRED
INFORMATION

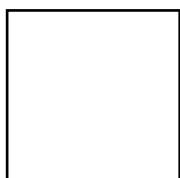

Forix™ IP 2X surface mounting switches and socket outlets

NEW



7 824 00



7 824 11



7 824 13



7 824 17

Conform to IEC standard. Complete mechanisms supplied with rocker and cover plate - Screw terminals IP2X. 2 finishes:
 - White RAL R903 - Gloss finish
 - Ivory RAL R113 - Gloss finish

Pack	Cat. No.	Switches 10 AX - 250 V~	German standard socket outlets 16 A - 250 V~ (continued)
1/20 1/20	7 824 00 7 824 30	One-way switch ○ White ● Ivory 	3 x 2P+E socket with shutters for child protection Inclined 45° - Horizontal or vertical mounting ○ White ● Ivory
1/20 1/20	7 824 04 7 824 34	Two-way switch ○ White ● Ivory 	French standard socket outlets 16 A - 250 V~ 2P+E socket with shutters for child protection ○ White ● Ivory
1/20 1/20	7 824 02 7 824 32	2 gang one-way switch ○ White ● Ivory 	RJ 11 telephone sockets Automatic connection by piercing the insulating material Supplied with a tool ○ White ● Ivory
1/20 1/20	7 824 05 7 824 35	Push-buttons 6 A - 250 V~ Become illuminated with lamp Cat. No. 7 824 57 ○ White ● Ivory 	Television sockets Terminal TV socket Male connector Ø9.52 mm ○ White ● Ivory
1/20 1/20	7 824 10 7 824 40	2P socket outlets 16 A - 250 V~ 2P socket outlets - without shutters ○ White ● Ivory 	RJ 45 sockets cat. 5e - UTP Automatic connection by piercing the insulating material Supplied with a tool ○ White ● Ivory
1/10 1/10	7 824 12 7 824 42	2 x 2P socket outlets - without shutters Inclined 45° - Horizontal or vertical mounting ○ White ● Ivory 	Wire outlets Supplied with cable ties ○ White ● Ivory
1/20 1/20	7 824 11 7 824 41	German standard socket outlets 16 A - 250 V~ 2P+E socket without shutters ○ White ● Ivory 	Dismatic - 20 A For protection and control of air-conditioning system Single pole 220 V/380 V thermal MCB ○ White
1/10 1/10	7 824 13 7 824 43	2 x 2P+E socket without shutters Inclined 45° - Horizontal or vertical mounting ○ White ● Ivory 	Lamp 230 V - Consumption 3.4 mA
1/20 1/20	7 824 20 7 824 50	2P+E socket with shutters for child protection ○ White ● Ivory 	
1/10 1/10	7 824 23 7 824 53	2 x 2P+E socket with shutters for child protection Inclined 45° - Horizontal or vertical mounting ○ White ● Ivory 	

Forix™ IP 44 switches and socket outlets



7 823 60

7 823 93

7 823 91

Conform to IEC standard: switches IEC 60669-1 (01-2007), socket outlets IEC 60884-1 (07-2006)

Mechanisms supplied complete with cover plates and plates

Surface mounting - screw terminals

2 finishes: White RAL R903 (Gloss finish); Grey RAL R735 (Gloss finish)

Mechanisms with single large rocker become illuminated with lamp Cat. No. 7 823 98

Pack	Cat. No.	Switches 10 AX - 250 V~
1/10	7 823 60	One-way switch <input type="radio"/> White <input type="radio"/> Grey
1/10	7 823 80	
1/10	7 823 63	Two-way switch <input type="radio"/> White <input type="radio"/> Grey
1/10	7 823 83	
1/10	7 823 62	2 gang one-way switch <input type="radio"/> White <input type="radio"/> Grey
1/10	7 823 82	
1/10	7 823 61	2 gang two-way switch <input type="radio"/> White <input type="radio"/> Grey
1/10	7 823 81	
1/10	7 823 66	Double pole switch <input type="radio"/> White <input type="radio"/> Grey
1/10	7 823 86	
1/10	7 823 65	Intermediate switch <input type="radio"/> White <input type="radio"/> Grey
1/10	7 823 85	
1/10	7 823 64	Push-buttons 6 A - 250 V~ <input type="radio"/> White <input type="radio"/> Grey
1/10	7 823 84	
5/50	7 823 79	Spare membrane glands <input type="radio"/> White <input type="radio"/> Grey
5/50	7 823 99	
5/50	7 823 98	Lamp 230 V - Consumption 3.4 mA

Pack	Cat. No.	German standard socket outlets 16 A - 250 V~ + switches
1/10	7 823 73	With shutters 2P+E socket <input type="radio"/> White <input type="radio"/> Grey
1/10	7 823 93	
1/5	7 823 74	2 x 2P+E socket <input type="radio"/> White <input type="radio"/> Grey
1/5	7 823 94	
1/5	7 823 71	One-way switch + 2P+E socket <input type="radio"/> White <input type="radio"/> Grey
1/5	7 823 91	
1/5	7 823 72	Double pole switch + 2P+E socket <input type="radio"/> White <input type="radio"/> Grey
1/5	7 823 92	
1/10	7 823 75	With shutters 2P+E socket <input type="radio"/> White <input type="radio"/> Grey
1/10	7 823 95	
1/5	7 823 77	2 x 2P+E socket <input type="radio"/> White <input type="radio"/> Grey
1/5	7 823 97	
1/5	7 823 76	Two-way switch + 2P+E socket <input type="radio"/> White <input type="radio"/> Grey
1/5	7 823 96	

Forix™ workstations





NEW

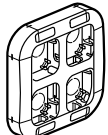
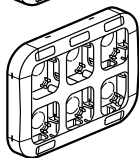
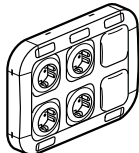

7 824 97 + 2 x RJ 45 sockets Cat. No. 7 824 24

Conform to IEC standard
 Ensure cable separation when fully equipped
 Label marking areas
 Pre-cut entries from 20 x 12.5 mm up to 40 x 12.5 mm
 Take flush-mounting flexible conduits and surface-mounting mini-trunking
 The workstations are composed of one plate and one cover plate
 Workstations for integration of Forix IP2X surface mounting mechanisms or Mosaic™ mechanisms with adaptor Cat. No. 7 824 25
 White RAL R903 - Gloss finish

Pack	Cat. No.	Workstations to be equipped
1/2	7 824 94	Accept all mechanisms in the Forix IP2X surface mounting range 4 gang 
1/2	7 824 96	Horizontal or vertical mounting 6 gang 
1/2	7 824 97	Equipped workstations Equipped with: - 4 x 2P+E German standard socket outlets with shutters - 2 blanking plates for integration of Forix mechanisms 

Pack	Cat. No.	RJ 45 keystone connector adaptor
1/20	7 824 26	Double connector ○ White 
1/20 1/20	7 824 21 7 824 51	RJ 11 telephone socket and RJ 45 cat. 5e - UTP socket Automatic connection by piercing the insulating material Supplied with a tool ○ White ● Ivory 
1/20	7 824 28	Double RJ 45 sockets cat. 5e - UTP Automatic connection by piercing the insulating material Supplied with a tool ○ White 
1/10	7 824 25	Mosaic™ adaptor Take 2-module Mosaic™ mechanisms ○ White 
1/20	7 824 95	Blanking plate Accessory to fill unused workstation spaces 1 gang 



Headquarters

128, avenue de Lattre de Tassigny
87045 Limoges Cedex
France
Tel : + 33 (0) 5 55 06 87 87
Fax : + 33 (0) 5 55 06 74 55

www.legrand.com